

LFL Series

Burner Flame Safeguard Control

The LFL... is a compact electro-mechanical primary flame safeguard control designed to provide burner sequencing, automatic ignition and continuous flame monitoring for gas, oil, and dual fuel, single burner applications.

The LFL... is applicable for on-off, multi-stage or modulating burners. The LFL... is designed for direct main burner ignition, intermittent or interrupted pilot operation.

The LFL... integrates the flame amplifier, purge timer and sequencer in a single control. Flame supervision is accomplished using UV sensor or flame rod detection.



ISO 9001
ISO 14001
REGISTERED FIRM



Features

- Primary flame safeguard control
- Visual sequence indication
- Optional combustion air blower control
- Optional postpurge
- Preignition interlock
- Continuous flame monitoring, including extraneous light detection
- UV sensor functional test
- Proven air switch function
- Proven high fire purge interlock
- Proven low fire ignition interlock
- Direct main burner ignition, intermittent or interrupted pilot operation
- Integrated flame amplifier
- UV sensor or flame rod detector
- Lockout alarm terminal
- Local and optional remote reset
- Burner off – economy position (fully closed air damper interlock)
- Unit fuse and spare fuse provided

Contents

Control Interface	2
Installation.....	2
Ordering information	3
Wiring base	3
Specifications	4
Specifications continued	5
Description of oper controls	6
Ladder diagram external connections	7
Sequence Dial OPERATION	8
Sequence Dial FAULT and LOCKOUT	9
Sequence Chart.....	10
Dimensions	11

Control interface

Indicator dial visible through front window

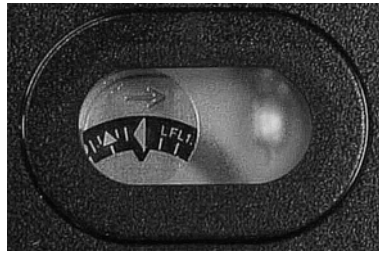

Lockout indicator light visible through front window

The LFL... reset button is integrated with the front window.

During a lockout condition, pressing the window resets the LFL...

Pressing* the window or remote reset during normal operation will lockout the LFL...



***Do not hold reset button for more than 10 seconds! (Local or remote), exceeding 10 seconds will damage control !**

Manually press the lockout reset button. Do NOT use any tools or pointed objects.



Indicator dial provides symbolic information about the program sequence, the type of fault, and the point in the sequence where the fault occurred.

The LFL... sequence is fixed and cannot be manually manipulated.

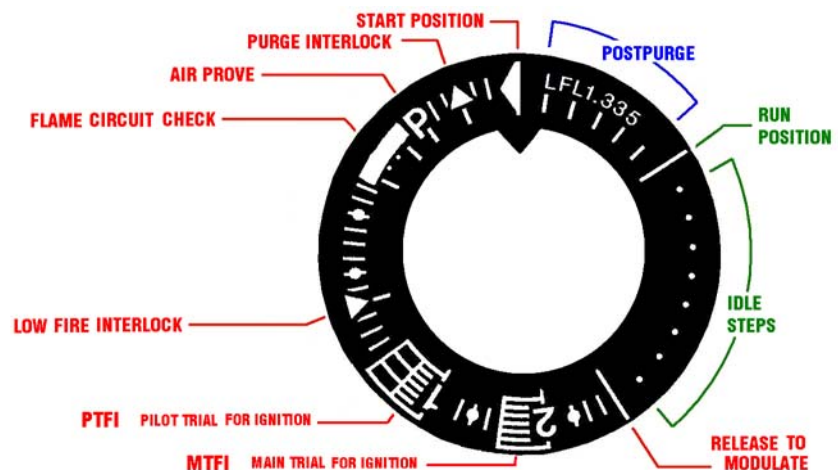

Installation





- All installation and commissioning work must be performed by qualified personnel.
- The LFL... must be mounted in an electrical enclosure, typically in the control panel.
- All wiring must comply with applicable electrical codes standards and regulations.
- Before performing any wiring to the LFL..., remove and isolate all power.
- High voltage AC wiring must not be installed in the same conduit as the flame detector wiring.
- Maximum 10 A slow external fuse is required.
- The LFL is not adversely affected by electromagnetic resonance.
- Ground the LFL... wiring base.
- Do not open or modify the LFL...
- When UV flame supervision is used, other sources of radiation, such as halogen lamps, welding equipment, ignition sparks can produce erroneous flame signals.

Ordering Information

Table 1	Product Numbers			
110 Vac 50/60 Hz *	LFL1.133-110V	LFL1.333-110V	LFL1.335-110V	LFL1.635-110V
220 Vac 50/60 Hz *	LFL1.133		LFL1.335	LFL1.635
Timing description				
Pre-purge time	7.5 sec	26 sec	31 sec	55 sec
Pilot trial for ignition (PTFI)	2.5 sec	4 sec	4 sec	
Main trial for ignition (MTFI)	2.5 sec		4 sec	
Interval from the beginning of MTFI until release to modulation	2.5 sec	10 sec	10.5 sec	
Post purge time	12 sec	15 sec	12 sec	
Flame failure response time (FFRT)	1 sec			

*All times listed above are for 60 Hz operation. (Times for 50 Hz operation will be 20% longer.)

	Description	Product Number
	LFL Control unit (without wiring base)	Refer to Table 1 above
	Wiring base	AGM410490550
	Flame sensor	
	UV (shown) forward looking 3/4" NPT	QRA 4.U
	UV QRA2... , QRA10 ...	Refer to Technical Instruction 7712
	Flame rod	By others

Wiring Base

The wiring base provides the following:

- 24 Terminals
- 3 Ground connections
- 3 Neutral connections, connected to terminal 2

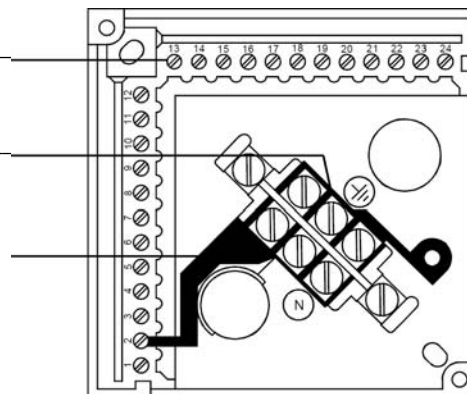

Specifications

General

Supply voltage	100 Vac -15 % ... 110 Vac +10 % 50/60 Hz ±6 % 220 Vac -15 % ... 240 Vac +10 % 50/60 Hz ±6 %
Internal fuse	6.3 A (slow)
External fuse	Maximum 10 A (slow)
Weight – LFL	2.2 lb
Weight – Wiring base	0.25 lb
Power consumption	3.5 VA
Mounting orientation	No restrictions

Terminal ratings

Terminal 1	Line	Maximum 5 A total load
Terminal 2	Neutral	N/A
Terminal 3	Alarm	1 A pilot duty
Terminals 4 to 5	Limit string	N/A
Terminals 6 and 7	Combustion Air Blower	Motor 4 FLA, 24 LRA or 1.6 A pilot duty
Terminals 8, 9, 10, 11	Damper actuator	N/A
Terminals 12, 13, 14	Air flow interlock	N/A
Terminal 16	Ignition transformer	4 A
Terminal 17	Pilot fuel valve	Motor 4 FLA, 24 LRA or 1.6 A pilot duty
Terminal 18	Main fuel valve	Motor 4 FLA, 24 LRA or 1.6 A pilot duty
Terminal 19	Main fuel valve	Motor 4 FLA, 24 LRA or 1.6 A pilot duty
Terminal 20	Damper actuator	N/A

Approvals

110V			
UL	File:	MH26134	Standard: UL372
CSA	Certificate:	1370843	Standard: CAN/CSA-C22.2 No 199-M89
FM	File:	J.I. 3003560	Standard: FM7610
110V & 220V			
CE	File:	CE-0085AP0001	Standard: DIN EN 298
FCC	Compliant		Part 15 Class B - Emissions

Environmental ratings

Vibration	0.5G Environment
Operation temperature range	-5...+140 °F < 95 % relative humidity
Storage temperature range	-58...+140 °F < 95 % relative humidity
 of water are not permitted!	Condensation, formation of ice and ingress

Specifications continued...

Flame supervision with UV sensor QRA...	Voltage – during burner operation	330 Vac \pm 10 %
	Voltage – during start-up phase (flame circuit check)	380 Vac \pm 10 %
UV sensor QRA...	Required minimum UV sensor signal	70 μ A
	Typical UV sensor signal measurement	100-450 μ A
QRA...	Length of detector cable (run in a separate conduit from all other wiring)	
	- Unshielded wire	max. 300 ft
	- Shielded cable, shield grounded to terminal 22	max. 600 ft

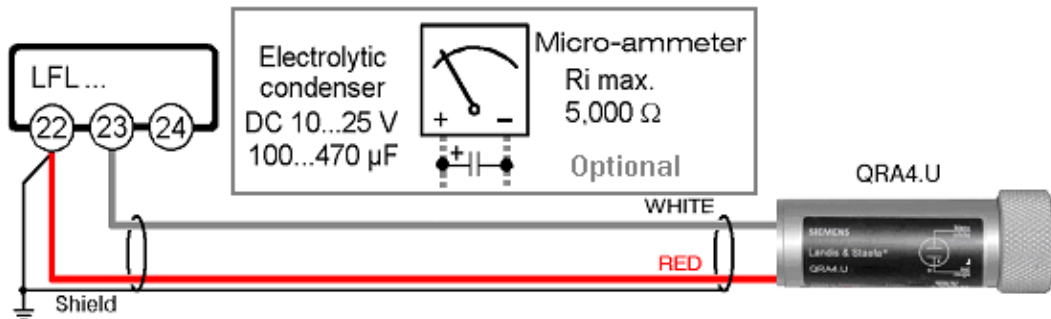

Flame supervision with Flame rod	Voltage at the flame rod – during burner operation	330 Vac \pm 10 %
	Voltage at the flame rod – during start-up phase (flame circuit check)	380 Vac \pm 10 %
Flame rod	Required minimum flame rod signal	6 μ A
	Typical flame signal measurement	20-100 μ A
Flame rod	Short-circuit current	max. 0.5 mA
	Length of detector cable (run in a separate conduit from all other wiring)	
	- Unshielded wire	max. 250 ft
- Shielded cable, shield grounded to terminal 22	max. 500 ft	

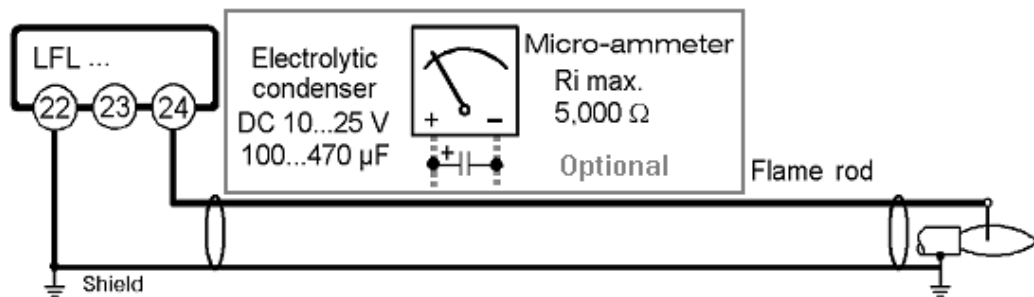

Electrical connection notes for flame supervision

- It is important to minimize electrical disturbance and signal loss.
- Run flame signal wiring separate from all other wiring
- Observe the length of detector cable as indicated above
- The flame rod does not provide protection from electric shock
- Locate the ignition electrode(s) and flame rod such that the ignition spark cannot arc to the flame rod (risk of electrical overload and damage to flame supervision circuit)
- When using the QRA..., grounding of terminal 22 is required
- Multiple UV sensors QRA... and/or flame rods can be connected in parallel
- If separate flame sensors are used for pilot and main flame supervision, an interrupted pilot must be utilized

Description of operating controls and their functions

Power Reset and Alarm	<p>LFL input (1) HOT and LFL input (2) NEUTRAL are used for control power, LFL output (3) ALARM, for alarm indication</p> <p>LFL input (21) RESET, as show for reset and/or remote shutdown</p>
Operating limit OLS	Pressure or temperature activated, the operating limit switch (OLS), <i>Closes</i> , for burner start-up sequence to begin, and <i>Opens</i> , for a burner controlled shutdown
Limit switches	Pressure, temperature, or level activated, limit switches examples include:
LGP	Low gas pressure (LGP) opens on low gas pressure
HGP	High gas pressure (HGP) opens on high gas pressure
LWS	Low water switch (LWS) opens on low water
High Limit	<p>These limit and are considered either to be <i>recycle</i> or <i>non-recycle</i>, (manual reset), and are connected between; LFL output (5) RECYCLE and LFL input (4) RECYCLE</p> <p>Recycle limit switches are used when it is desirable to stop the burner when the switch opens, and restart it again, automatically, when the switch closes again.</p> <p>Non-recycle limit switches are used when it is desirable to <i>lockout</i> the burner when the switch opens and prevent it from automatically restarting again. These switches must be manually reset, on the switch itself, as well as require you to push the reset button on the LFL to allow a new start-up sequence.</p> <p>The <i>High Limit</i> switch is almost always a non-recycle limit switch, and is usually connected to; LFL input (1) HOT</p> <p>NFPA 85, CSD-1 and UL795 require the HGP, LGP to cause a shutdown and be manually reset. Most burner / boiler insurance codes also require a LWS.</p>
Fuel proof of closure POC	<p>The fuel proof of closure (POC) switch is integral to the fuel valve and activated by the valve mechanics. The POC prevents a burner start-up if the fuel valve is not in the proved close position.</p> <p>LFL input (12) POC, is provided for this purpose. Note -This is a 'Precondition for Startup' and must be powered to start a sequence.</p>
Combustion air blower CAB	<p>The combustion air blower (CAB) provides combustion air to the burner. Not all installations require the LFL to control the CAB. The LFL provides terminals for two options:</p> <p>LFL output (7) M2, powered after a 2 sec delay, and continues through postpurge.</p> <p>LFL output (6) M1, powered immediately, and stops prior to postpurge.</p>
Combustion air switch CAS	<p>The combustion air switch (CAS) is used to prove that combustion air is being provided. Most burner / boiler insurance codes require a CAS.</p> <p>LFL input (14) COMBUSTION AIR PROVE, is connected to the normally open (NO) terminal of the CAS, and closes when air pressure is present.</p> <p>LFL input (13) COMBUSTION AIR TEST SW, is connected to the normally closed (NC) terminal of the CAS, to make sure the contacts have not welded.</p>
Ignition	<p>The LFL provides options for; <i>interrupted pilot</i>, <i>intermittent pilot</i>, and <i>direct ignition as follows</i>;</p> <p>LFL output (16) IGNITION, for the ignition transformer</p> <p>LFL output (17) PILOT, for interrupted (pilot on only during ignition), or for intermittent (pilot on when burner is on)</p> <p>LFL output (18) MAIN DIR IGN, for the main fuel valve on direct ignition</p> <p>LFL output (19) MAIN PILOT, for the main fuel valve on piloted ignition</p>
High fire purge interlock OPEN	<p>Generally, an actuator position switch, or a differential pressure switch, that is used to prove the actuator is at the high fire position. Some codes require the high fire position (open) be proved during prepurge.</p> <p>LFL output (9) OPEN, is provided to drive the actuator to this position. *See Note below</p>
Low fire start interlock MINIMUM	<p>This switch is also, generally, an actuator position switch, that is used to prove the actuator is at the low position. Some codes require the low fire (minimum) position be proved during ignition.</p> <p>LFL output (10) MINIMUM, is provided to drive the actuator to this position. *See Note below</p>
Fully closed ECONOMY	<p>This switch is as well, generally another actuator position switch that proves it is at the fully closed (economy) position. This position is desired following post purge to minimize heat losses.</p> <p>LFL output (11) ECONOMY, is provided to drive the actuator to this position. *See Note below</p>
Release to modulate Flame sensor input	<p>*Note LFL input (8) FEEDBACK, is provided to confirm each of these positions.</p> <p>LFL output (20) RELEASE, enables an external load controlled and/or to indicate "Burner On"</p> <p>LFL inputs (22) (23) (24) FLAME can be used for a UV sensor or flame rod</p>

Wiring Diagram

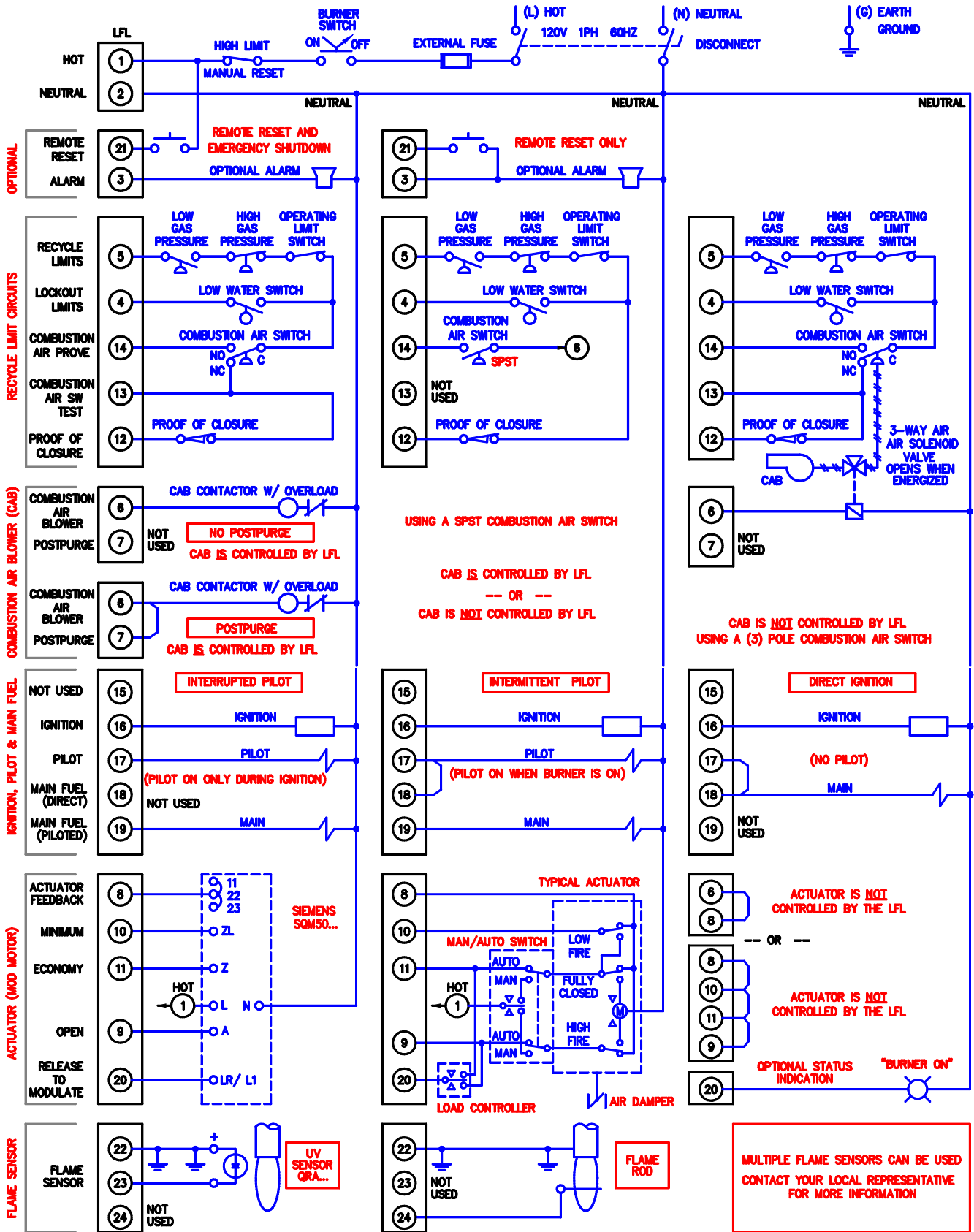



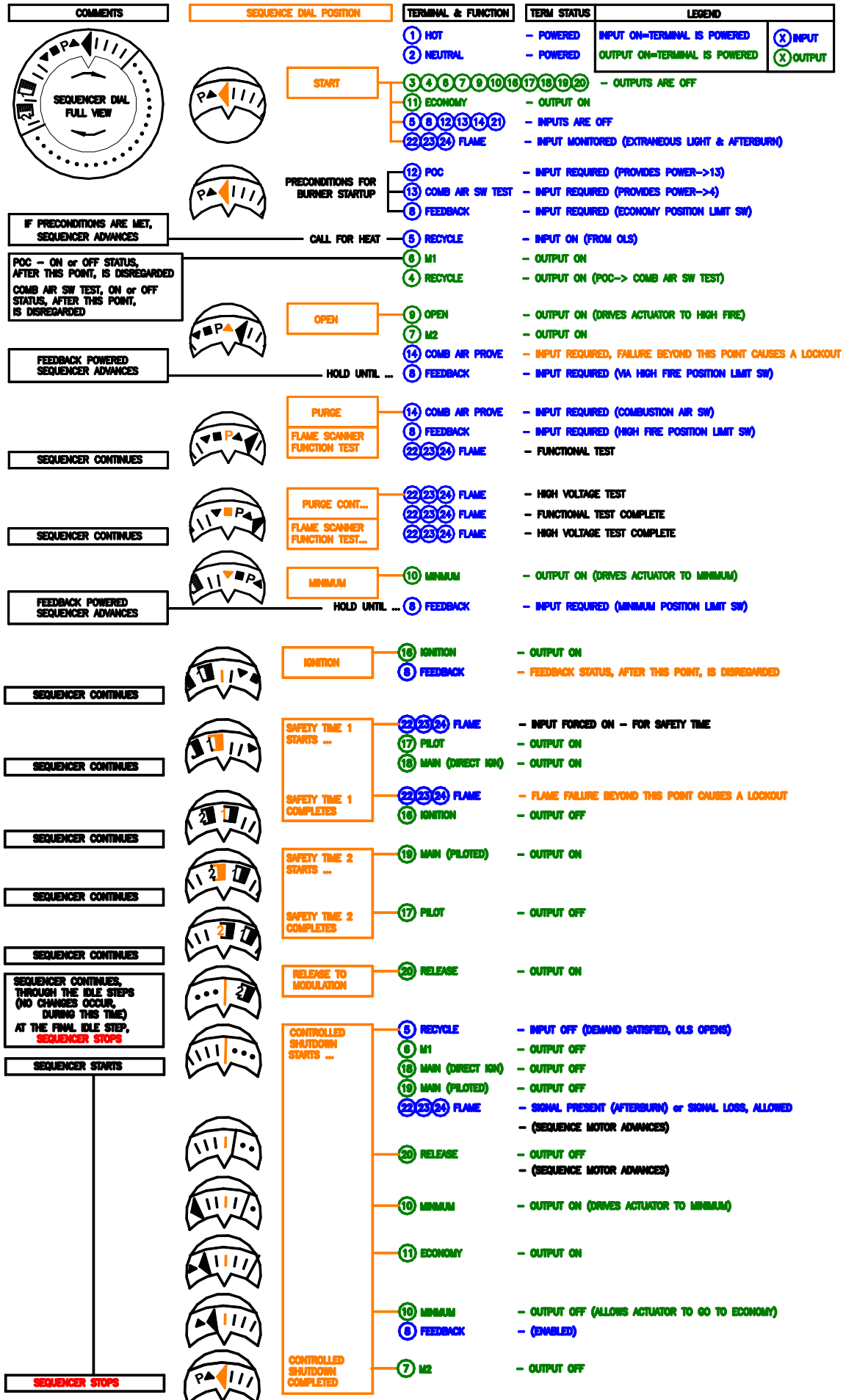





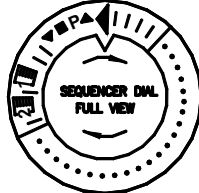







Sequence dial – OPERATION

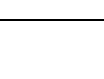

Sequence dial – FAULT and LOCKOUT indication

IF A FAULT CONDITION OCCURS, THE SEQUENCER WILL STOP
 IF A LOCKOUT OCCURS, THE SEQUENCER WILL STOP, AND THE L1 FAULT LIGHT WILL ILLUMINATE
 THE SEQUENCER DIAL WILL INDICATE THE POSSIBLE CAUSE

COMMENTS	SEQUENCE DIAL POSITION	POSSIBLE FAULT OR LOCKOUT CAUSE
		
		<p>START (22)(23)(24)</p> <p>FLAME SIGNAL IS MONITORED POSSIBLE CAUSE – IF EXTRANEODUS LIGHT IS DETECTED → LOCKOUT POSSIBLE CAUSE – FLAMES THAT HAVE NOT BEEN EXTINGUISHED DUE TO LEAKING FUEL VALVES POSSIBLE CAUSE – DEFECT IN FLAME SUPERVISION CIRCUIT</p>
		<p>NO START POSSIBLE CAUSE – PRECONDITIONS FOR BURNER STARTUP HAVE NOT BEEN MET</p>
		<p>PRECONDITIONS FOR BURNER STARTUP : (12) POC MUST BE POWERED POSSIBLE CAUSE – POC SWITCH CONTACTS ARE OPEN (OR VALVE IS STUCK OPEN)</p> <p>(13) COMB AIR SW TEST MUST BE POWERED POSSIBLE CAUSE – SWITCH CONTACTS ARE OPEN</p> <p>(8) RECYCLE MUST BE POWERED – POSSIBLE CAUSE – ONE OR MORE LIMIT SWITCHES ARE OPEN, INCLUDING – LOP, HOP, LIS, OLS</p> <p>(8) FEEDBACK MUST BE POWERED POSSIBLE CAUSE – ECONOMY POSITION LIMIT SWITCH IN ACTUATOR NOT CLOSED</p>
<p>FAULT SEQUENCER WILL REMAIN ON HOLD INDEFINATELY</p>	HOLD UNTIL ...	
		<p>OPEN (22)(23)(24)</p> <p>FLAME SIGNAL IS MONITORED POSSIBLE CAUSE – IF EXTRANEODUS LIGHT IS DETECTED → LOCKOUT</p> <p>FEEDBACK MUST BE POWERED POSSIBLE CAUSE – OPEN POSITION LIMIT SWITCH IN ACTUATOR NOT CLOSED</p>
<p>FAULT SEQUENCER WILL REMAIN ON HOLD INDEFINATELY</p>	HOLD UNTIL ...	
		<p>PURGE (14)</p> <p>COMB AIR PROVE MUST BE POWERED IF CIRCUIT IS NOT COMPLETED BY THIS POINT → LOCKOUT IF CIRCUIT OPENS AT ANY TIME BEYOND THIS POINT → LOCKOUT</p>
		<p>FLAME SCANNER HIGH VOLTAGE TEST (22)(23)(24)</p> <p>FLAME SIGNAL IS MONITORED POSSIBLE CAUSE – SELF IGNITING UV SCANNER → LOCKOUT POSSIBLE CAUSE – IF EXTRANEODUS LIGHT IS DETECTED → LOCKOUT</p>
		<p>PURGE CONT... FLAME SCANNER FUNCTION TEST... (22)(23)(24)</p> <p>FLAME SIGNAL IS MONITORED POSSIBLE CAUSE – DEFECT IN FLAME SUPERVISION CIRCUIT → LOCKOUT POSSIBLE CAUSE – IF EXTRANEODUS LIGHT IS DETECTED → LOCKOUT</p>
		<p>PURGE CONT... FLAME SCANNER FUNCTION TEST... (22)(23)(24)</p> <p>FLAME SIGNAL IS MONITORED POSSIBLE CAUSE – DEFECT IN FLAME SUPERVISION CIRCUIT → LOCKOUT POSSIBLE CAUSE – IF EXTRANEODUS LIGHT IS DETECTED → LOCKOUT</p>
<p>FAULT SEQUENCER WILL REMAIN ON HOLD INDEFINATELY</p>	HOLD UNTIL ...	
		<p>MINIMUM (22)(23)(24)</p> <p>FLAME SIGNAL IS MONITORED POSSIBLE CAUSE – IF EXTRANEODUS LIGHT IS DETECTED → LOCKOUT</p> <p>FEEDBACK MUST BE POWERED POSSIBLE CAUSE – MINIMUM POSITION LIMIT SWITCH IN ACTUATOR NOT CLOSED</p>
		<p>IGNITION (22)(23)(24)</p> <p>FLAME SIGNAL IS MONITORED POSSIBLE CAUSE – IF EXTRANEODUS LIGHT IS DETECTED → LOCKOUT</p>
		<p>SAFETY TIME 1 STARTS ... (22)(23)(24)</p> <p>FLAME SIGNAL IS FORCED ON DURING SAFETY TIME 1)</p>
		<p>SAFETY TIME 1 COMPLETES (22)(23)(24)</p> <p>FLAME SIGNAL IS MONITORED POSSIBLE CAUSE – FLAME SIGNAL NOT RECEIVED BY END OF 1ST SAFETY TIME → LOCKOUT</p>
		<p>SAFETY TIME 2 STARTS ... (22)(23)(24)</p> <p>FLAME SIGNAL IS MONITORED POSSIBLE CAUSE – FLAME SIGNAL LOST BY END OF 2ND SAFETY TIME → LOCKOUT</p>
		<p>SAFETY TIME 2 COMPLETES (22)(23)(24)</p> <p>FLAME SIGNAL IS MONITORED POSSIBLE CAUSE – FLAME SIGNAL LOST DURING IDLE TIME → LOCKOUT</p>
		<p>RELEASE TO MODULATION (22)(23)(24)</p> <p>FLAME SIGNAL IS MONITORED POSSIBLE CAUSE – FLAME SIGNAL LOST DURING IDLE TIME → LOCKOUT</p>
		<p>CONTROLLED SHUTDOWN STARTS ... (22)(23)(24)</p> <p>FLAME SIGNAL IS MONITORED POSSIBLE CAUSE – IF EXTRANEODUS LIGHT IS DETECTED → LOCKOUT POSSIBLE CAUSE – FLAMES THAT HAVE NOT BEEN EXTINGUISHED DUE TO LEAKING FUEL VALVES POSSIBLE CAUSE – DEFECT IN FLAME SUPERVISION CIRCUIT</p>
		<p>CONTROLLED SHUTDOWN COMPLETED (22)(23)(24)</p>

Program Sequence

PROGRAM SEQUENCE CHART

INPUT Required
 INPUT Allowed
 INPUT NOT Allowed
 Output ON (Powered)
 Output OFF
 N/A

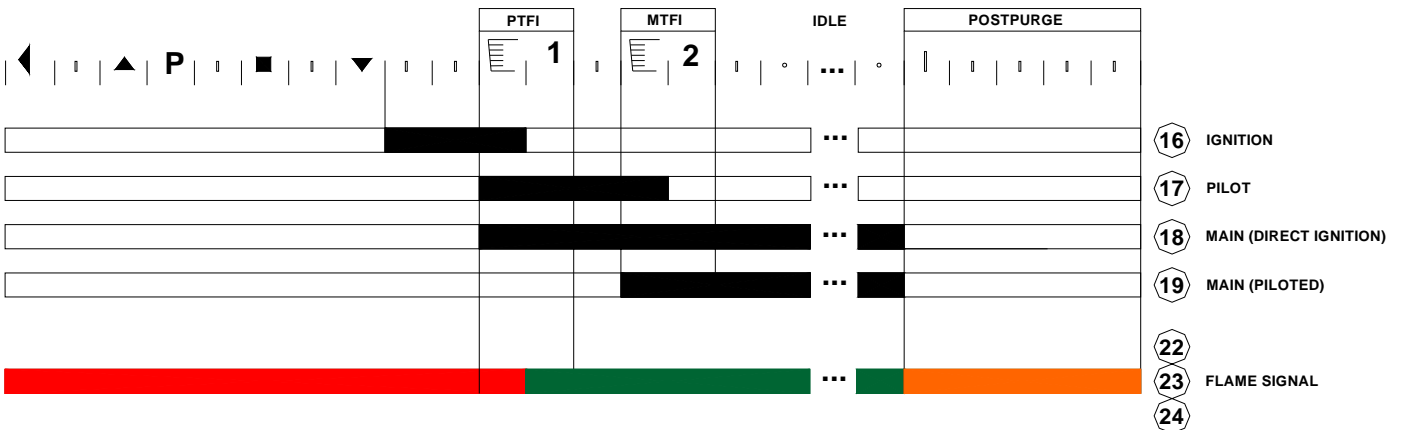
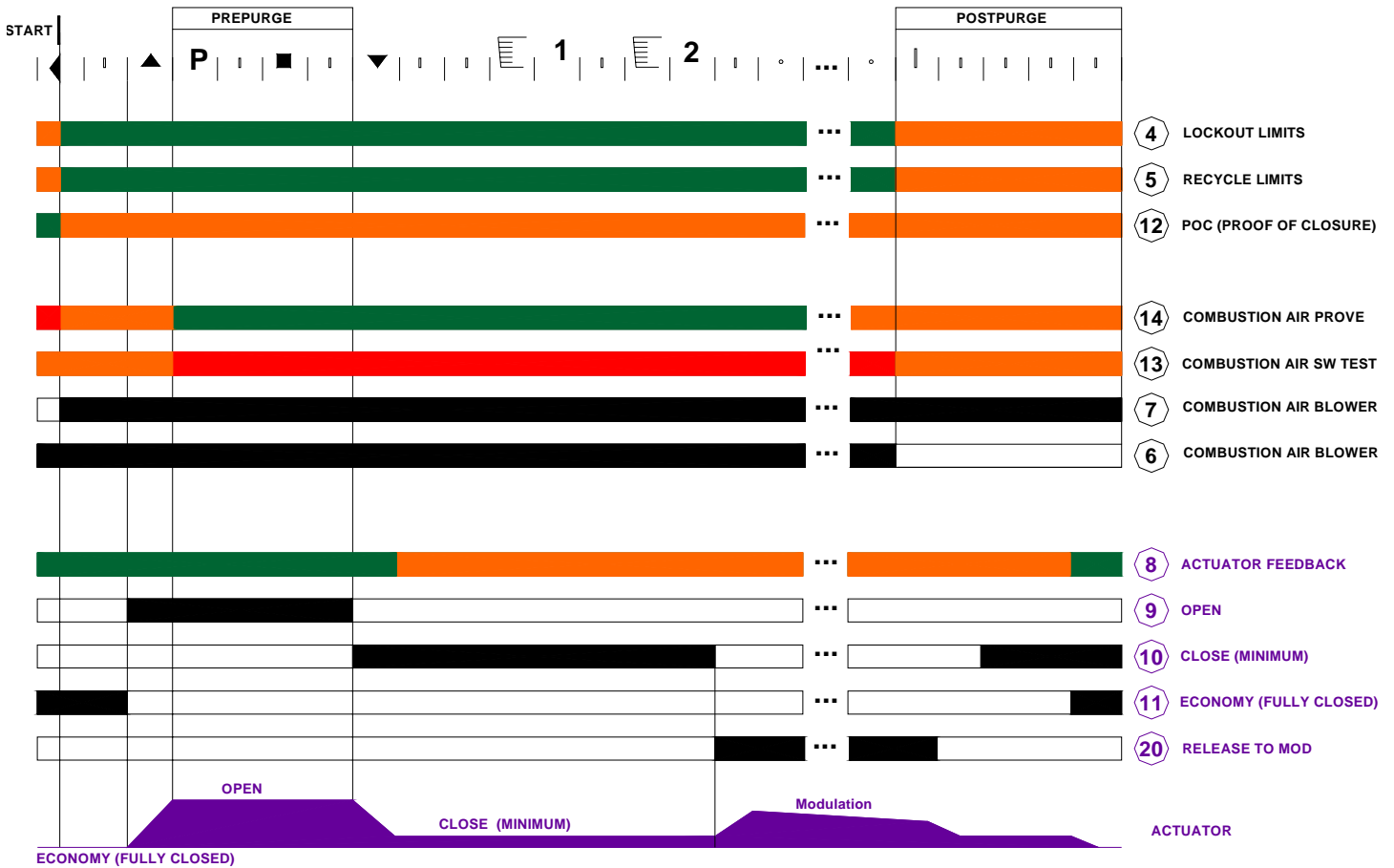
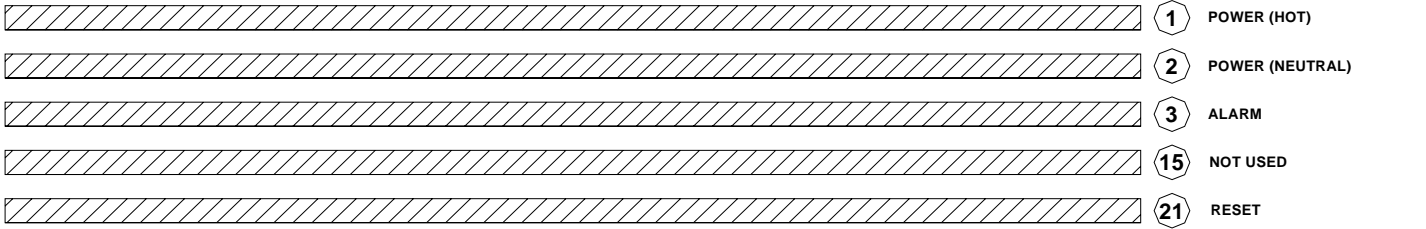

Dimensions

Dimensions in inches

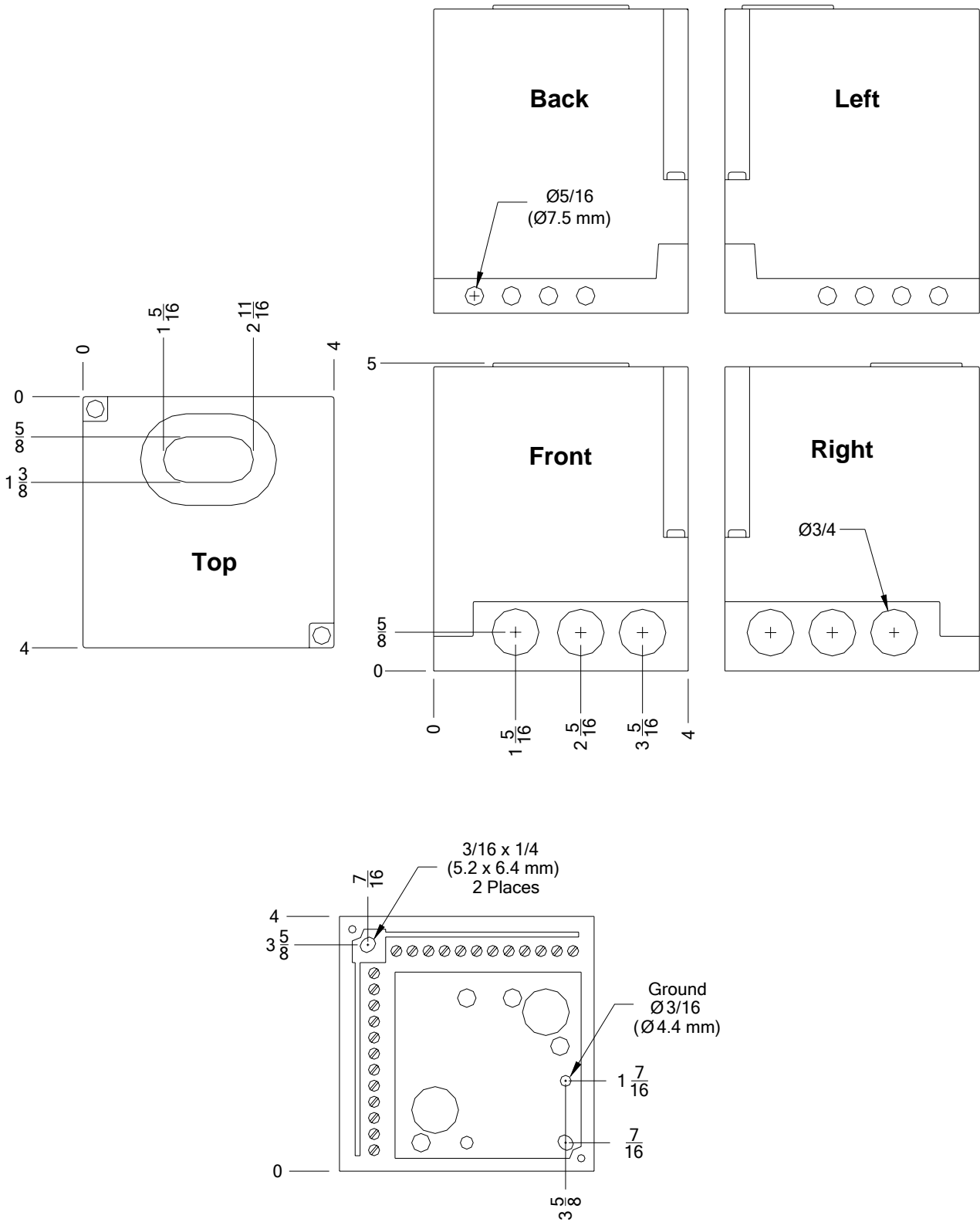

Dimensions QRA4.U

Dimensions in inches

